

# Jerrycan

## B.04



# 4L



# Jerrycan B.04



## Specification

<b>Usage</b>	Packaging for transportation and storage of hazardous substances, food & beverages, industrial chemicals (automotive, household and construction chemicals, oils, etc.
<b>Volume capacity (L)</b>	4,0
<b>Color</b>	White, Natural (other colors on request)
<b>Neck (mm)</b>	Ø 35,0
<b>Cap (mm)</b>	DIN 44
<b>Induction heating seal</b>	-
<b>Control cap ring</b>	+
<b>Viewing stripe</b>	+
<b>Height (mm)</b>	260,0
<b>Length (mm)</b>	171,0
<b>Width (mm)</b>	127,0
<b>Label place dimensions (mm)</b>	140,0*115,0
<b>UN-certification</b>	Available upon request
<b>Material</b>	HDPE

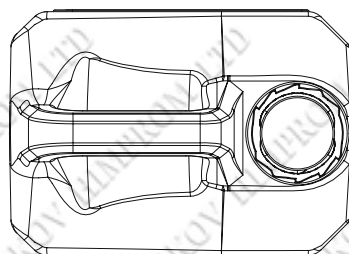
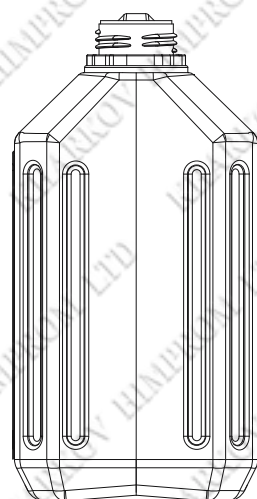
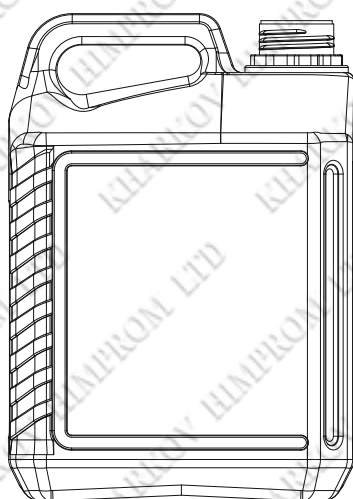

**Kharkov Himprom LTD.**

22, Promyslova str., Vasyshevo  
Kharkov region, 62495 Ukraine  
E-mail: [export\\_dep@kharkov-himprom.com](mailto:export_dep@kharkov-himprom.com)  
<https://kharkov-himprom.com/>



ISO 9001:2015 certified  
Quality Management System

# Jerrycan B.04

## Logistics

### Option 1

#### Cans location in package

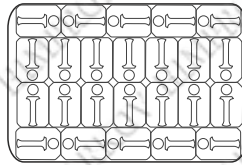

Package size with cans:  
900 mm x 600 mm x 270 mm

Cans number in package:  
24

#### Cans location on pallet

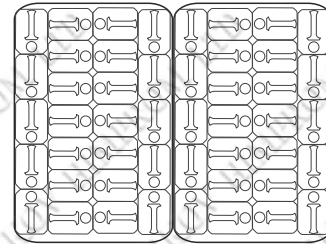
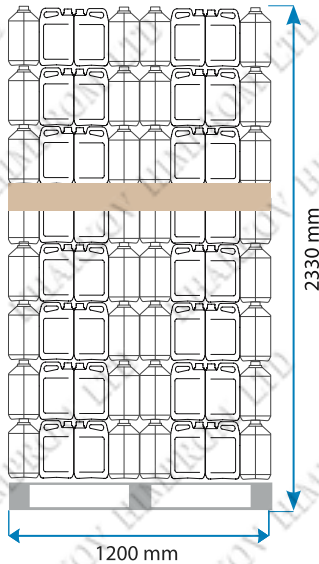

Rows per pallet:  
8

Cans per row:  
48

Cans per pallet:  
384

### Option 2

#### Cans location in package

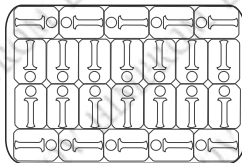

Package size with cans:  
900 mm x 600 mm x 270 mm

Cans number in package:  
24

#### Cans location on pallet

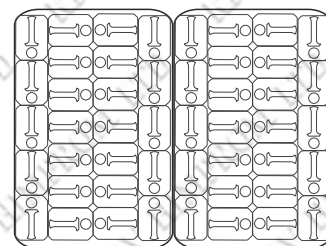
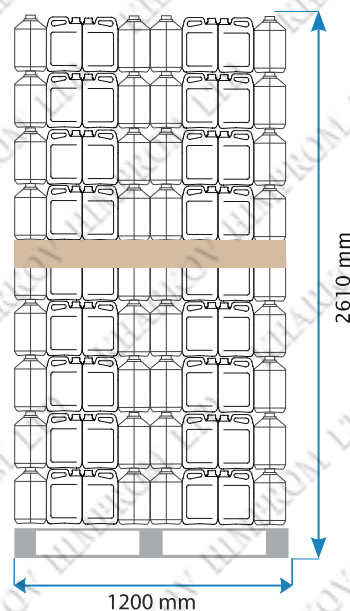

Rows per pallet:  
9

Cans per row:  
48

Cans per pallet:  
432



**Kharkov Himprom LTD.**

22, Promyslova str., Vasyshevo  
Kharkov region, 62495 Ukraine  
E-mail: [export\\_dep@kharkov-himprom.com](mailto:export_dep@kharkov-himprom.com)  
<https://kharkov-himprom.com/>



ISO 9001:2015 certified  
Quality Management System